

**Moosgummi - Zargenprofile**

Teil 1

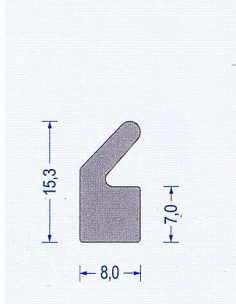

Art.-Nr. 2150001  
 EPDM grau  
 VE : 50 m Bund

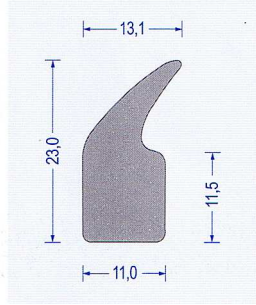

Art.-Nr. 2150002  
 EPDM grau  
 VE : 50 m Bund

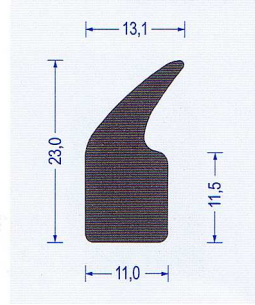

Art.-Nr. 2150003  
 EPDM schwarz  
 VE : 50 m Bund

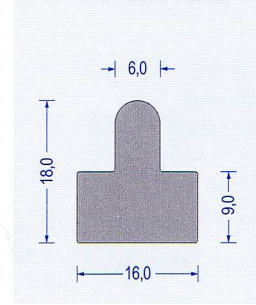

Art.-Nr. 2150004  
 EPDM grau  
 VE : 50 m Bund

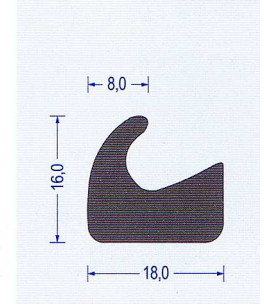

Art.-Nr. 2150005  
 EPDM schwarz  
 VE : 25 m Bund

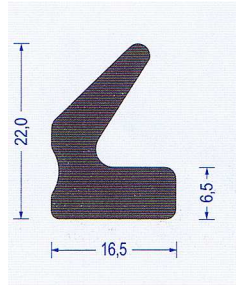

Art.-Nr. 2150006  
 EPDM schwarz  
 VE : 25 m Bund

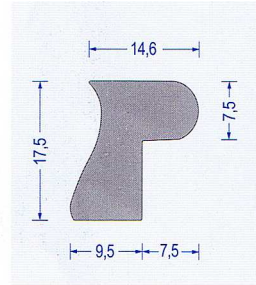

Art.-Nr. 2150007  
 EPDM grau  
 VE : 50 m Bund

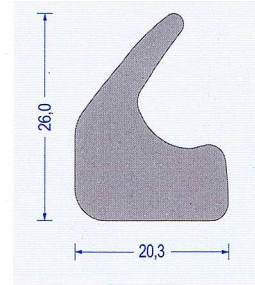

Art.-Nr. 2150008  
 EPDM grau  
 VE : 25 m Bund

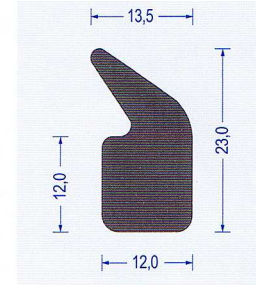

Art.-Nr. 2150009  
 CR schwarz  
 VE : 50 m Bund

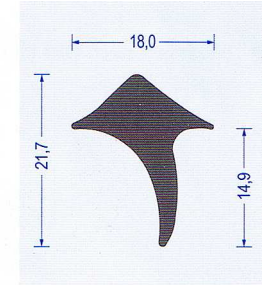

Art.-Nr. 2150010  
 EPDM schwarz  
 VE : 50 m Bund

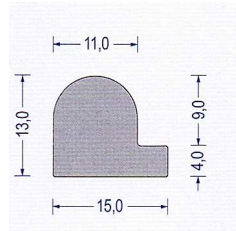

Art.-Nr. 2150011  
 EPDM - grau  
 VE : 50 m Bund

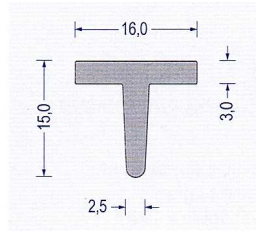

Art.-Nr. 2150012  
 EPDM - grau  
 VE : 25 m Bund

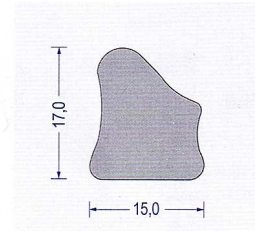

Art.-Nr. 2150013  
 EPDM - grau  
 VE : 50 m Bund

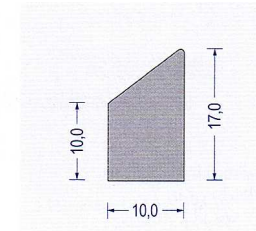

Art.-Nr. 2150014  
 NR - grau  
 VE : 100 m Bund

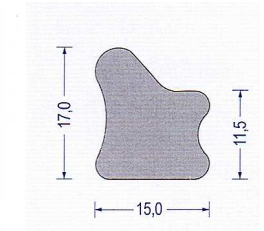

Art.-Nr. 2150015  
 EPDM grau  
 VE : 50 m Bund

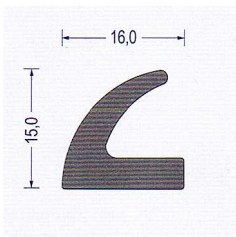

Art.-Nr. 2150016  
 EPDM - schwarz  
 VE : 25 m Bund



Art.-Nr. 2150017  
 EPDM schwarz eins. sk  
 VE : 25 m Bund

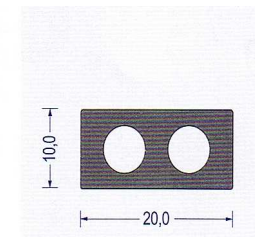

Art.-Nr. 2150018  
 EPDM schwarz  
 VE : 50 m Bund

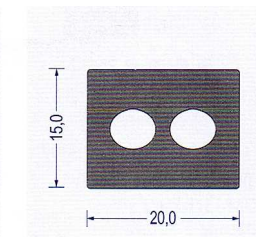

Art.-Nr. 2150019  
 EPDM schwarz  
 VE : 50 m Bund

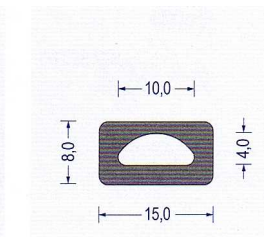

Art.-Nr. 2150020  
 EPDM schwarz  
 VE : 100 m Bund

## Moosgummi - Zargenprofile

Teil 2

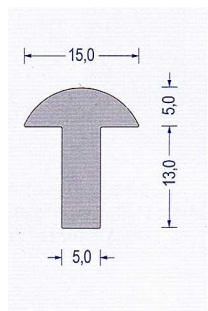

Art.-Nr. 2150021  
 EPDM grau  
 VE : 50 m Bund

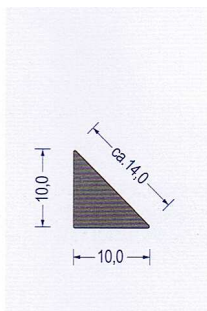

Art.-Nr. 2150022  
 EPDM grau  
 VE : 50 m Bund

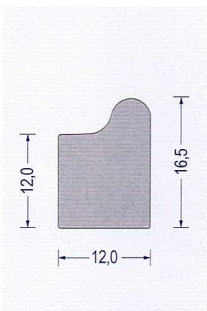

Art.-Nr. 2150023  
 EPDM grau  
 VE : 50 m Bund

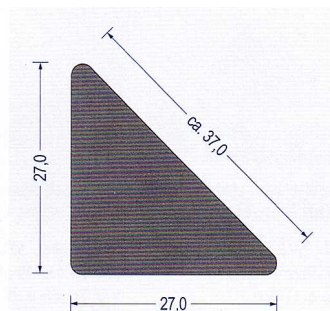

Art.-Nr. 2150024  
 EPDM schwarz  
 VE : 25 m Bund

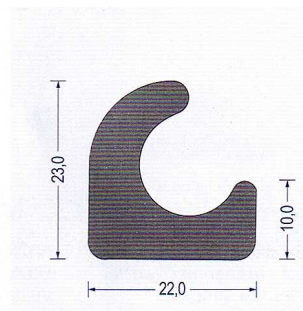

Art.-Nr. 2150025  
 EPDM schwarz  
 VE : 25 m Bund

## Moosgummi - Riefenprofile

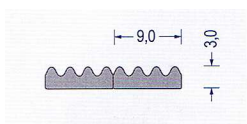

Art.-Nr. 2170001  
 EPDM grau  
 VE : 300 m Spule  
 Doppelmeter m.Abrißkante

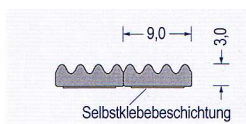

Art.-Nr. 2170002  
 EPDM grau sk\*  
 VE : 300 m Spule  
 Doppelmeter m.Abrißkante

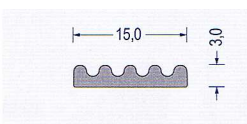

Art.-Nr. 2170003  
 EPDM grau  
 VE : 150 m Spule

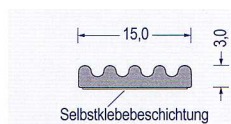

Art.-Nr. 2170004  
 EPDM grau sk\*  
 VE : 150 m Spule

## Zellgummi - Sonderprofil SK

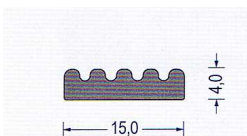

Art.-Nr. 2170005  
 EPDM schwarz  
 VE : 100 m Spule

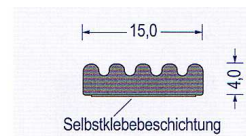

Art.-Nr. 2170006  
 EPDM schwarz sk\*  
 VE : 100 m Spule

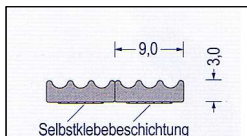

Art.-Nr. 2172001  
 EPDM(Krone) - grau sk\*  
 VE : 140 m Spule  
 Doppelmeter m.Abrißkante



Art.-Nr. 2171001  
 EPDM(P) - grau sk\*  
 VE : 100 m Spule  
 Doppelmeter m.Abrißkante

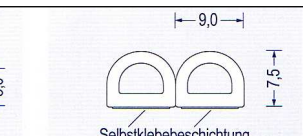

Art.-Nr. 2171002  
 EPDM(D) - weiß sk\*  
 VE : 200 m Spule  
 Doppelmeter m.Abrißkante

## Koextrusionsprofil

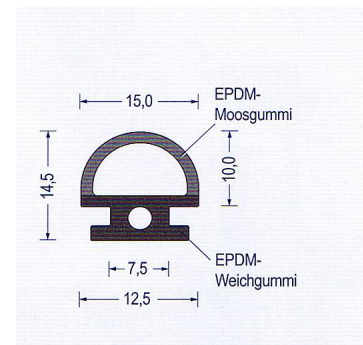

Art.-Nr. 2180001  
 EPDM 70°20° schwarz  
 VE : 100 m Bund

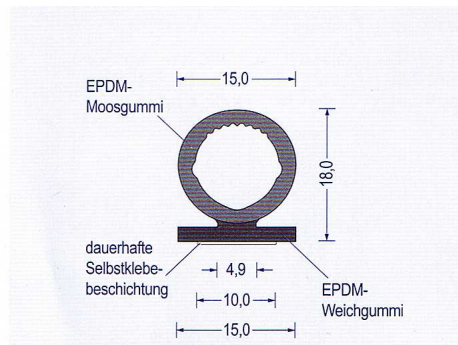

Art.-Nr. 2180002  
 EPDM schwarz skd\*  
 VE : 100 m Bund

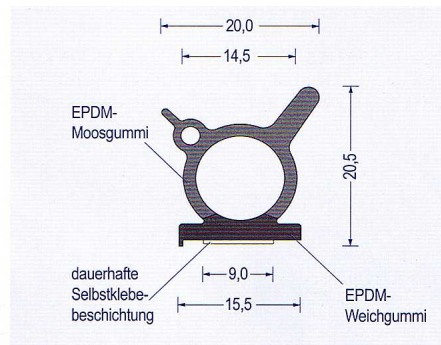

Art.-Nr. 2180003  
 EPDM schwarz skd\*  
 VE : 50 m Bund

sk\* = selbstklebend einseitig als Montagehilfe  
 skd\* = dauerhaft selbstklebend ( Acrylic Foam )

Toleranzen nach DIN ISO 3302-1 E3 ( Moosgummi )  
 Toleranzen nach DIN ISO 3302-1 E2 ( Gummi )