

Kantenschutz - Profile aus Weichgummi mit Dichtprofil aus EPDM- Moosgummi

Flexible Kantenschutz - Dichtprofile aus Gummi und Moosgummi mit eingebettetem Metallklemmband oder -draht, zum Umkleiden von Kanten, selbsttätig klemmend, mit gleichzeitiger Dichtfunktion, aus EPDM Gummi und Moosgummi, gut witterungs- und alterungsbeständig.

Temperaturbeständigkeit von -30°bis +70°C.

Toleranzen Gummi nach DIN ISO 3302-1 E2 , Moosgummi nach DIN ISO 3302-1 E3

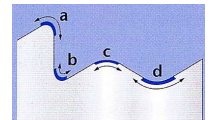

*Biegeradien

Die angegebenen Klemmbereiche und kleinstmöglichen Biegeradien sind unverbindliche Hinweise.

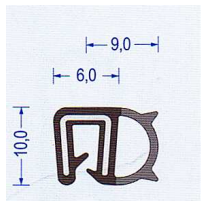

Art.-Nr. 2830001
 EPDM schwarz
 Klemmber. 2-2,5 mm
 VE : 100 m Bund
 Br* a20/b20/c20/d60

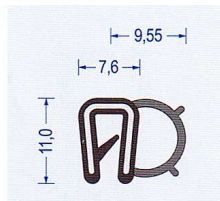

Art.-Nr. 2830002
 EPDM schwarz
 Klemmber. 1-2 mm
 VE : 50 m Bund
 Br* a40/b50/c30/d80

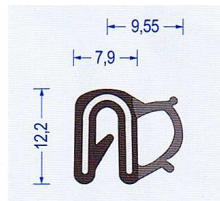

Art.-Nr. 2830003
 EPDM schwarz
 Klemmber. 0,8-2,5 mm
 VE : 50 m Bund
 Br* a40/b40/c100/d30

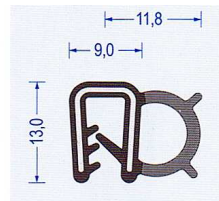

Art.-Nr. 2830004
 EPDM schwarz
 Klemmber. 2 mm
 VE : 50 m Bund
 Br* a50/b20/c120/d40

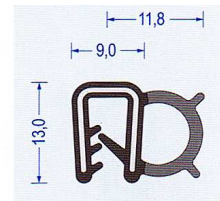

Art.-Nr. 2830005
 NBR schwarz
 Klemmber. 2 mm
 VE : 50 m Bund
 Br* a50/b20/c120/d40

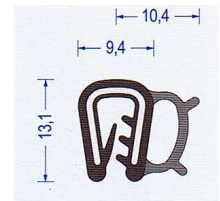

Art.-Nr. 2830006
 EPDM schwarz
 Klemmber. 2 mm
 VE : 50 m Bund
 Br* a30/b40/c30/d60

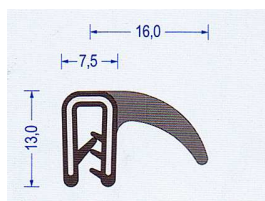

Art.-Nr. 2830007
 EPDM schwarz
 Klemmber. 1-2 mm
 VE : 50 m Bund
 Br* a80/b40/c200/d200

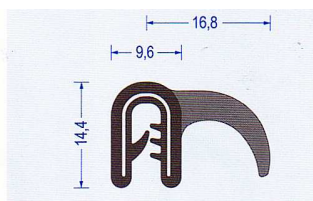

Art.-Nr. 2830008
 EPDM schwarz
 Klemmber. 1-2,5 mm
 VE : 100 m Bund
 Br* a80/b120/c-d-

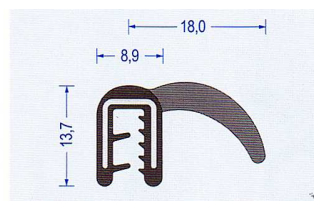

Art.-Nr. 2830009
 EPDM schwarz
 Klemmber. 2-3 mm
 VE : 50 m Bund
 Br* a45/b10/c75/d250

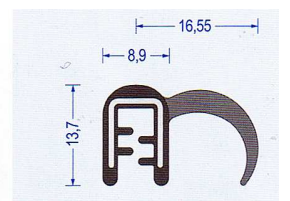

Art.-Nr. 2830010
 EPDM schwarz
 Klemmber. 1-3 mm
 VE : 50 m Bund
 Br* a200/b30/c200/d75

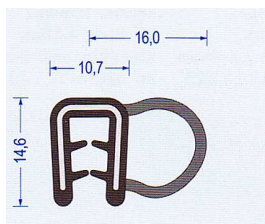

Art.-Nr. 2830011
 EPDM schwarz
 Klemmber. 1,5-3 mm
 VE : 100 m Bund
 Br* a40/b30/c180/d40

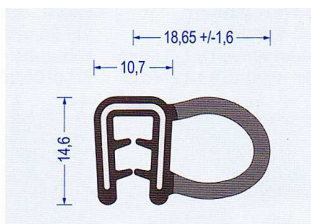

Art.-Nr. 2830012
 EPDM schwarz
 Klemmber. 1,5-3 mm
 VE : 25 m Bund
 Br* a80/b60/c200/d80

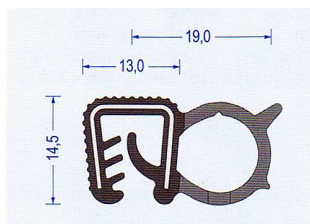

Art.-Nr. 2830013
 EPDM schwarz
 Klemmber. 2-4 mm
 VE : 75 m Bund
 Br* a80/b60/c102/d100

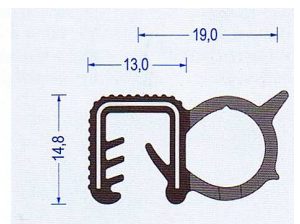

Art.-Nr. 2830014
 EPDM schwarz
 Klemmber. 4-6 mm
 VE : 75 m Bund
 Br* a80/b60/c120/d100

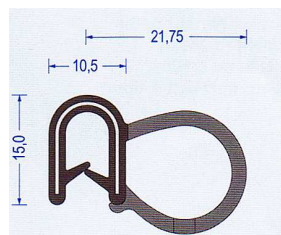

Art.-Nr. 2830015
 EPDM schwarz
 Klemmber. 1-3,5 mm
 VE : 25 m Bund
 Br* a200/b80/c200/d200

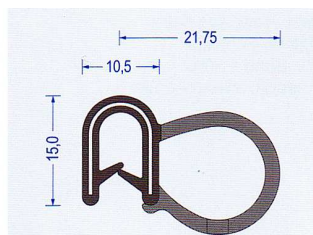

Art.-Nr. 2830016
 CR schwarz
 Klemmber. 1-3,5 mm
 VE : 25 m Bund
 Br* a200/b80/c200/d200

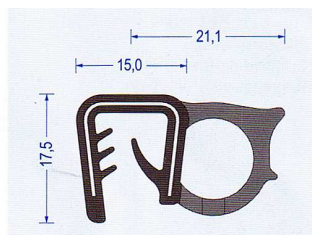

Art.-Nr. 2830017
 EPDM schwarz
 Klemmber. 5-9 mm
 VE : 50 m Bund
 Br* a80/b60/c-d-

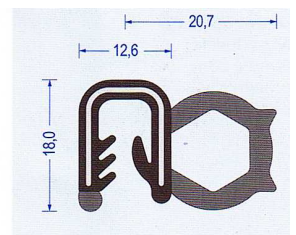

Art.-Nr. 2830018
 EPDM schwarz
 Klemmber. 3-5 mm
 VE : 50 m Bund
 Br* a80/b25/c150/d70

Kantenschutz - Profile aus Weichgummi mit Dichtprofil aus EPDM- Moosgummi

Flexible Kantenschutz - Dichtprofile aus EPDM Gummi und Moosgummi mit eingebettetem Metallklemmband oder -draht, zum Umkleiden von Kanten, selbsttätig klemmend, mit gleichzeitiger Dichtfunktion, aus EPDM Gummi und Moosgummi, gut witterungs- und alterungsbeständig,

Temperaturbeständigkeit von -30° bis +70°C.

Toleranzen Gummi nach DIN ISO 3302-1 E2, Moosgummi nach DIN ISO 3302-1 E3

Die angegebenen Klemmbereiche und kleinstmöglichen Biegeradien sind unverbindliche Hinweise.

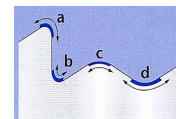

*Biegeradien



Art.-Nr. 2830019
 EPDM schwarz
 Klemmber. 1-2 mm
 VE : 100 m Bund
 Br* a50/b70/c10/d10

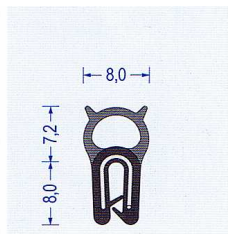

Art.-Nr. 2830020
 EPDM schwarz
 Klemmber. 0,5-1,5 mm
 VE : 50 m Bund
 Br* a50/b80/c25/d25

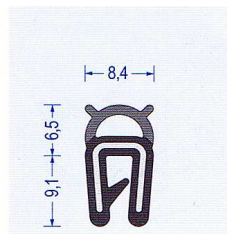

Art.-Nr. 2830021
 EPDM schwarz
 Klemmber. 1-2 mm
 VE : 50 m Bund
 Br* a50/b60/c20/d20

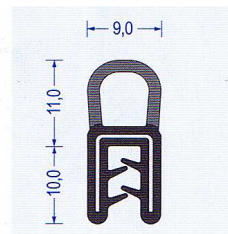

Art.-Nr. 2830022
 EPDM schwarz
 Klemmber. 1-2,5 mm
 VE : 100 m Bund
 Br* a60/b120/c25/d25

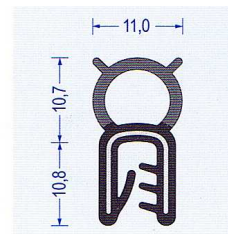

Art.-Nr. 2830023
 EPDM schwarz
 Klemmber. 1-3 mm
 VE : 50 m Bund
 Br* a50/b180/c30/d30

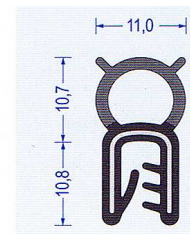

Art.-Nr. 2830024
 NBR schwarz
 Klemmber. 1-3 mm
 VE : 50 m Bund
 Br* a50/b180/c30/d30

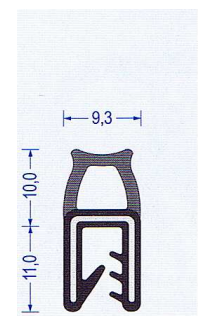

Art.-Nr. 2830025
 EPDM schwarz
 Klemmber. 1-3 mm
 VE : 50 m Bund
 Br* a60/b200/c25/d25

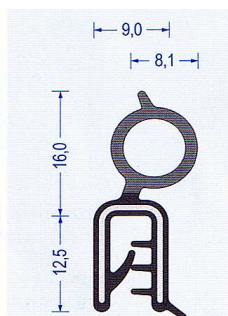

Art.-Nr. 2830026
 EPDM schwarz
 Klemmber. 1-2,5 mm
 VE : 100 m Bund
 Br* a100/b200/c100/d60

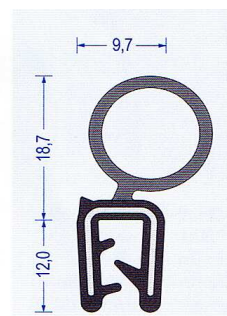

Art.-Nr. 2830027
 EPDM schwarz
 Klemmber. 1-3 mm
 VE : 50 m Bund
 Br* a160/b250/c200/d-

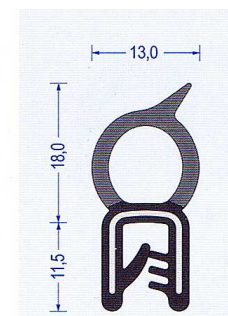

Art.-Nr. 2830028
 EPDM schwarz
 Klemmber. 1-2,5 mm
 VE : 50 m Bund
 Br* a100/b180/c25/d25



Art.-Nr. 2830029
 EPDM schwarz
 Klemmber. 2,5-4 mm
 VE : 50 m Bund
 Br* a100/b180/c25/d25

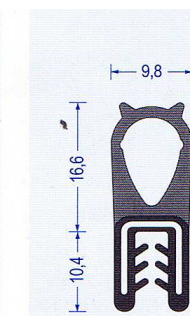

Art.-Nr. 2830030
 EPDM schwarz
 Klemmber. 1-3 mm
 VE : 50 m Bund
 Br* a80/b150/c20/d20

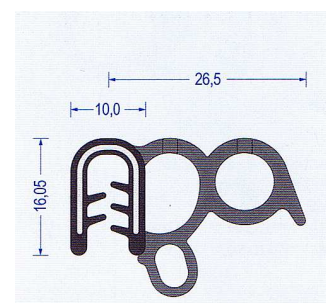

Art.-Nr. 2830031
 EPDM schwarz
 Klemmber. 1,5-3,5 mm
 VE : 25 m Bund
 Br* a40/b30/c180/d40

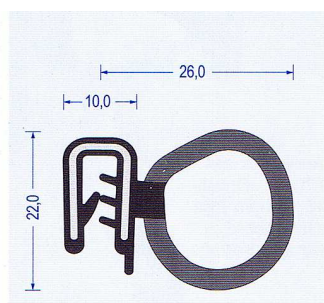

Art.-Nr. 2830032
 EPDM schwarz
 Klemmber. 1-3,5 mm
 VE : 50 m Bund

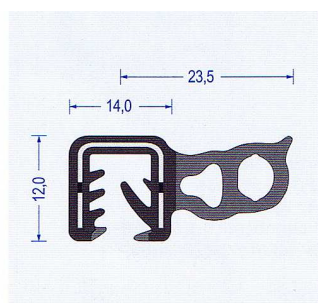

Art.-Nr. 2830033
 EPDM schwarz
 Klemmber. 4-6 mm
 VE : 50 m Bund

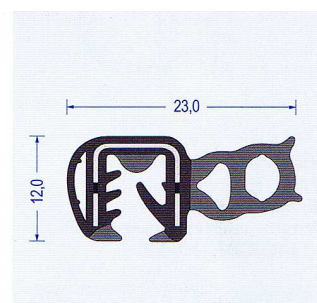

Art.-Nr. 2830034
 EPDM schwarz
 Klemmber. 4-6 mm
 VE : 50 m Bund